

CDL2 SERIES OUTDOOR LIGHTING

CDL2-80CW
CDL2-80NW
CDL2-80WW

Customer Name: _____

Project Name: _____

Note: _____

Type: _____



Ideal for indoor parking lots, commercial buildings, schools, warehouses, retail centers, apartment complexes. Designed for 9 to 16-foot mounting.

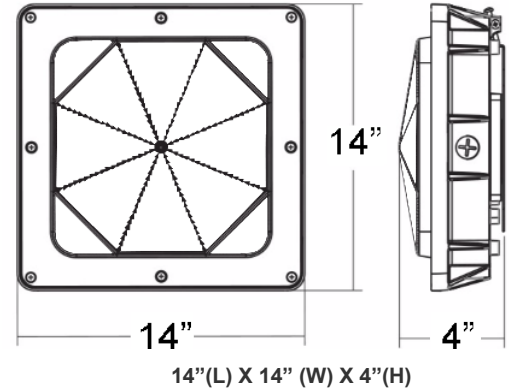

Features

- Housing: Die-cast aluminum with prismatic polycarbonate lens redesigned for LED
- Designed for 9 to 16 foot mounting heights
- Factory-Installed Options: Battery Backup, Motion Sensor
- 7-year warranty

Technical Specifications

Electrical:

- Input Wattage: 80W
- Input Current: 0.6A MAX
- Input Voltage: 120-277VAC 50/60Hz
- Power factor: >0.90
- Other wattages: 25W/ 45W/ 60W

Mechanical:

- Die-cast aluminum with bronze
- Four 1/2" threaded hubs located on four sides of the housing
- Prismatic polycarbonate lens
- Operating temperature: -4°F ~ 104°F
- IP rating: IP65, Wet Locations

Lighting:

- Dimming: 0~10V dimmable
- LED type/ Brand: SMD 3030/ Lumileds LEDs
- Total lumens: 9400 LM/ 9400 LM/ 9500 LM
- Color temperature: 3000K/ 4000K/ 5000K
- Color rendering index: >80
- Beam angle: 150°
- Lifespan: 70000 Hrs

Applications:

- Indoor Parking
- Commercial Buildings
- School
- Warehouses
- Complexes
- Apartment
- Garage

Other Models:

- | | | |
|----------------------------|----------------------------|----------------------------|
| • 25W 2880LM CDL2-25CW | • 45W 4400LM CDL2-45CW | • 60W 7400LM CDL2-60CW |
| • 25W 2800LM CDL2-25NW | • 45W 4300LM CDL2-45NW | • 60W 7100LM CDL2-60NW |
| • 25W 2780LM CDL2-25WW | • 45W 4200LM CDL2-45WW | • 60W 7100LM CDL2-60WW |



Photometrics: CDL2-80W

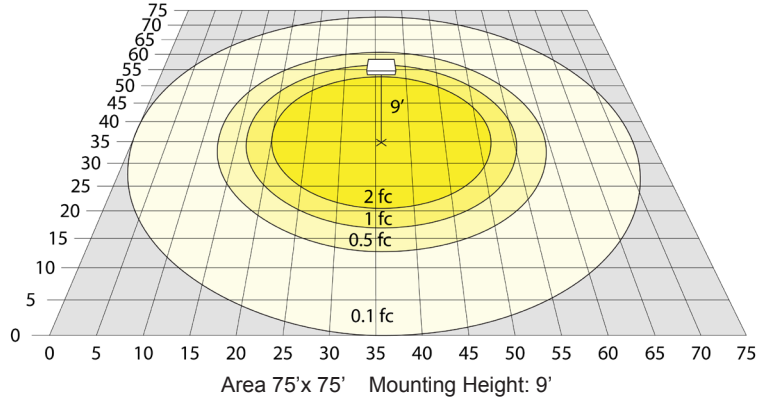
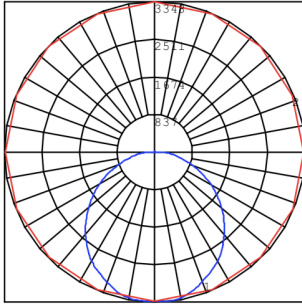
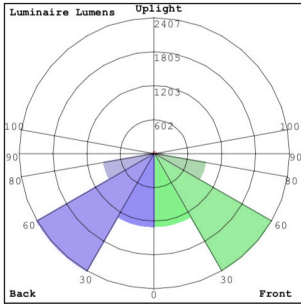

BUD Rating: B2-U2-G2

Other Views:

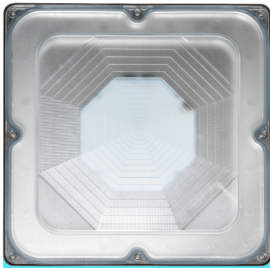

Front View



Side View

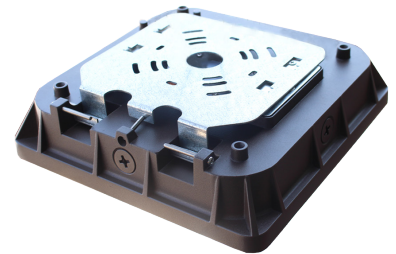

Back View

Performance Table: CDL2-80W

MODEL NO.	Wattage	Voltage	Lumens	Color Temp.	BUG Rating	LPW
CDL2-80CW	80W	120~277V	9500 LM	5000K	B3-U2-G2	118
CDL2-80NW	80W	120~277V	9400LM	4000K	B3-U2-G2	117
CDL2-80WW	80W	120~277V	9400LM	3000K	B3-U2-G2	117

Sample Ordering

Model Wattage Color Temp.

CDL2 - 80W -

WW = 5000K
NW = 4000K
CW = 5000K

Factory Installed Options

Blank = No Option For Factory-Instalaeed
OPT-EM-OD2INT = INTERNAL EMERGENCY BACKUP BATTERY
OPT-SEN-3MR-4 = PROGRAMMABLE MICROWAVE BI-LEVEL SENSOR
OPT-PC-B = PHOTOCCELL
WEC-8RC= OPTIONAL REMOTE CONTROL
OPT-TRS-T20= TAMPER RESISTANT SCREW

SENSOR AND REMOTE CONTROL OPTIONS



MOUNTING OPTIONS

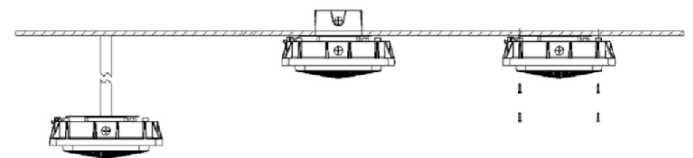

Example:

1. CDL2-80CW
2. CDL2-80CW
WEC-8RC
3. CDL2-80CW
WEC-8RC
OPT-SEN-3MR-4

(CDL2 80W 5000K fixture 120V-277V)

(CDL2 80W 5000K fixture 120V-277V)
(Remote Control)

(CDL2 80W 5000K fixture 120V-277V)
(Remote Control)
(Programmable Microwave Bi-Level)

WESTGATE

Phone: (877) 805-2252 | Fax: (877) 805-2252
www.westgatemfg.com | www.westgatecontrols.co

